

FläktGroup

AIRTREND Ltd
Predstavništvo u Beogradu
Kumanovska 14, 11000 Beograd
Tel: 011/3836886, 3085740
Faks: 011/3444113
e-mail: gobrid@eunet.rs
web: www.airtrend.rs

WATER-BASED AIR CONDITIONING SYSTEMS

» APPLICATION BROCHURE FOR FAN COILS
AND CHILLED BEAMS WITH CHILLERS/HEAT-PUMPS



Environmentally friendly generation of cooling & heating energy

With the new twin series of FGAC chillers and FGAH reversible heat pumps we have the right solution for the economical and ecological air conditioning of smaller buildings. Thanks to the scroll compressor with inverter technology and thus the precise delivery of capacity (25-100%) excellent seasonal efficiencies are achieved. The units are ideal for the combination with fan coils or chilled beams as indoor units.

Due to the energy transfer by a water cycle, the refrigeration circuit is limited within the outdoor unit only and as a consequence factory filled, sealed and tested. The low refrigerant charge of <11kg leads to lowest tons CO₂ equivalents compared to split-type air conditioning systems. In conclusion, the water-based system is especially future-proof with regard to the F-Gas directive.





Inverter scroll compressor



Electronic expansion valve



Brazed plate heat exchangers

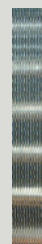

Cu/Al Air-side heat exchanger



Continuous speed fan

Accessories for all applications

- BMS-interface, Modbus connection
- Substructure buffer tank, 30 or 60 liters
- Hydronic equipment for indoor installation
100 or 200 liter buffer tank, hydraulic separator
- High-efficient pressure-controlled water pump
- Air-side heat exchanger coating for corrosive installation areas
- Installation equipment, anti-vibration mounts

10 unit sizes for small capacities

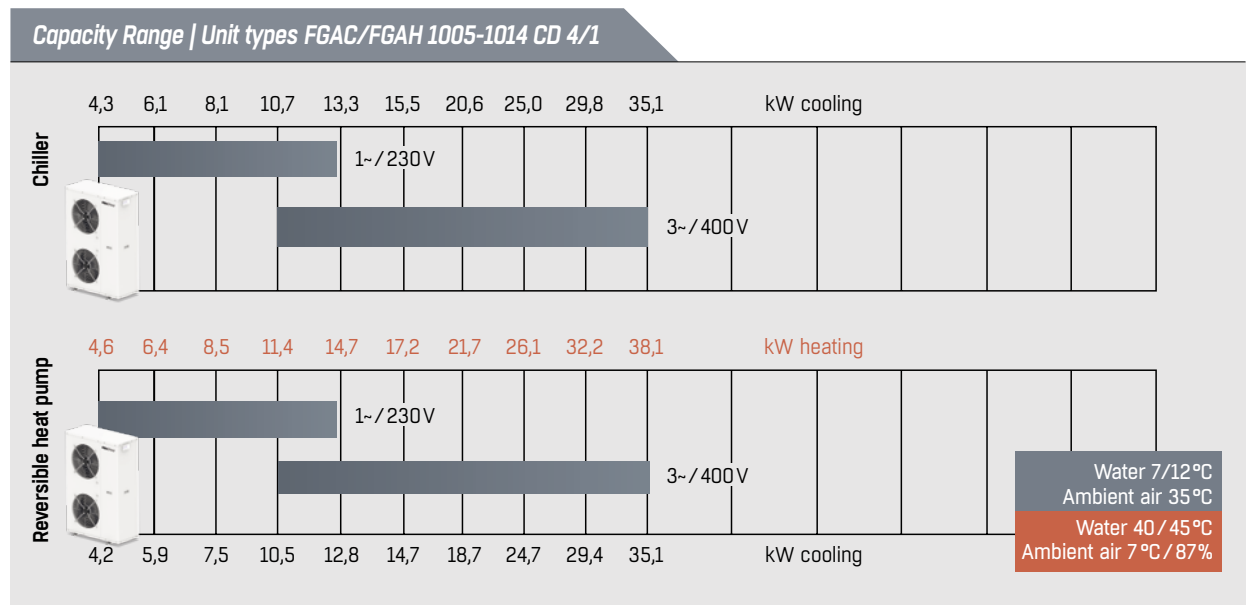

For larger projects with higher cooling and heating duties FläktGroup offer more than 25 different series of chillers and heat pumps of the FG/GL-series as well as 4-pipe units of the HeaMo series. All of them are available as air-to-water types or water-to-water types. Please ask your local FläktGroup sales office for further information.

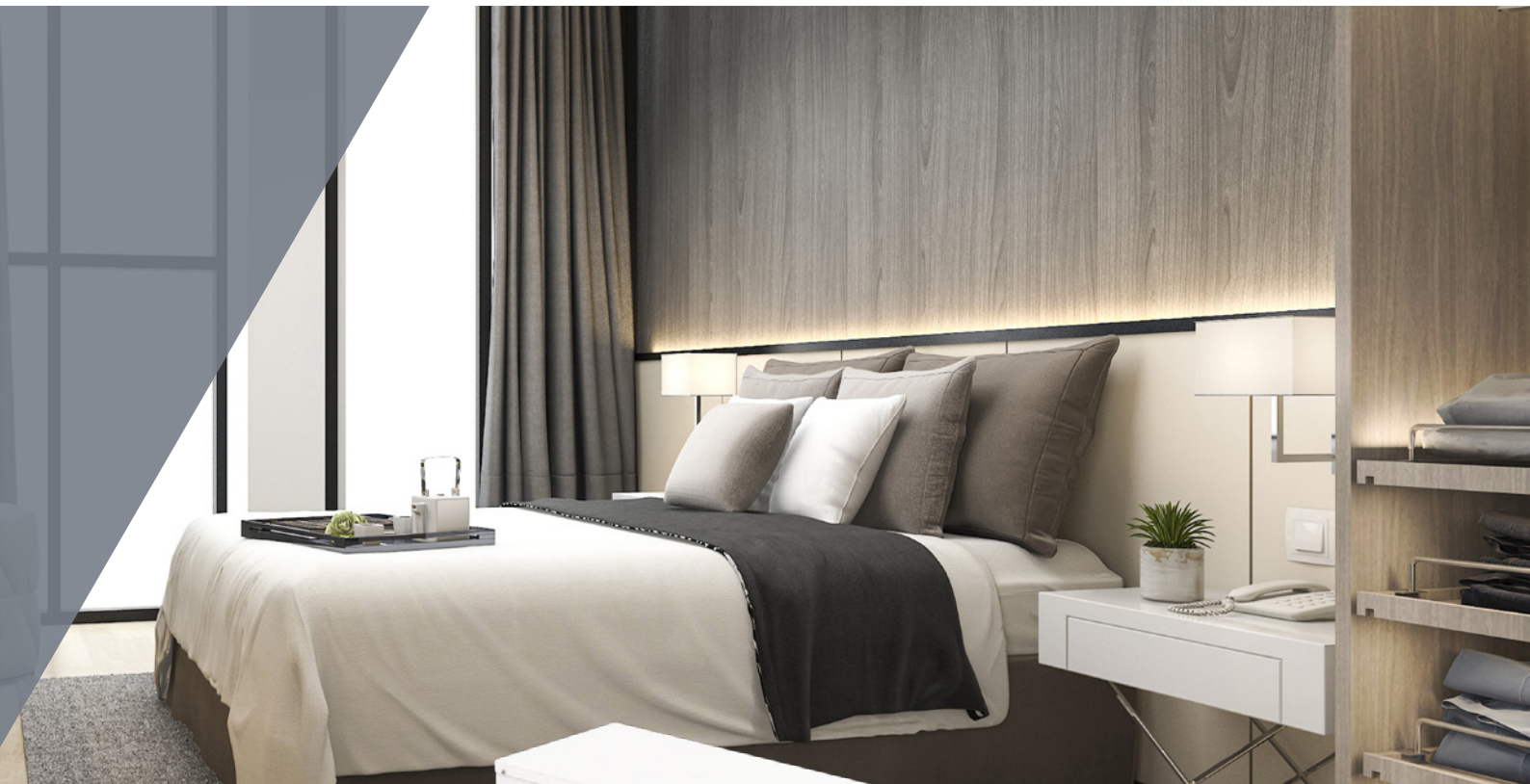

FGAC Chiller for cooling only



FGAC 1005-1014 CD 4/1 series

- Perfect for light commercial comfort application
- Plug & Play with built-in high-efficiency pump
- Seasonal energy efficiency ratio SEER up to 4.7 (η_s 185%)
- ERP 2021 compliant according to EU 2016/2281
- Cooling operation from -10 to $+45^\circ\text{C}$ ambient temperature
- Water outlet temperature from -8 to $+18^\circ\text{C}$
- Low refrigerant charge with less than 7kg (R-410A)

FGAH reversible heat-pump for cooling or heating



FGAH 1005-1014 CD 4/1 series



- Perfect for light commercial or residential comfort application
- Seasonal coefficient of performance SCOP up to 4.2 (η_s 163 %)
- Seasonal space heating energy class A++
- ERP compliant according to 813/2013 EU
- Cooling operation from $+10$ to $+45^\circ\text{C}$ ambient temperature
- Heating operation from -20 to $+45^\circ\text{C}$ ambient temperature
- Chilled water temperature from -8 to $+18^\circ\text{C}$
- Warm water temperature from $+24$ to 45°C and up to 60°C

Indoor climate at perfection

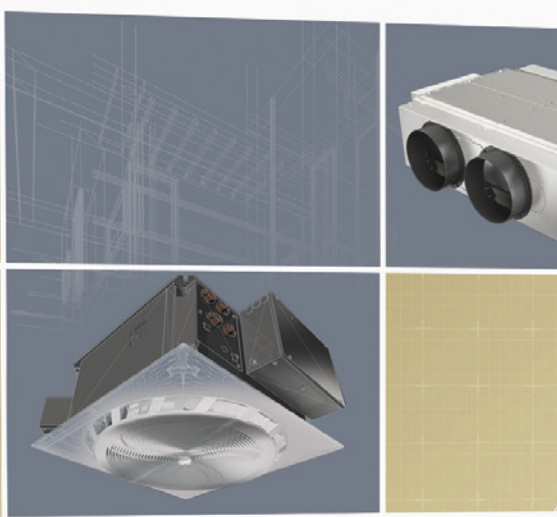
DESIGNA!R FCU SELECTION TOOL

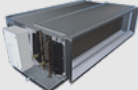

Fan Coils

	Performance Range***	Benefits
 <p>HyFlex-Geko*</p>	<p>Cabinet fan coil unit for hidden installation, e.g. suspended ceiling and bulkheads</p> <p>Total cooling: 1 - 10 kW</p> <p>Heating: 1 - 11.5 kW</p> <p>Sound pressure level**: 20 - 52 dB(A)</p>	<ul style="list-style-type: none"> • 360° Flex technology • "Plug-and-play" with mounted accessories • High performance with strong EC-fan XT (eXtended Technology) and with FläktGroup pressure independent valve control • High customization based on wide range of accessory
 <p>Cassette-Geko®</p>	<p>Cassette fan coil unit for installation in Euro-pattern and suspended ceilings</p> <p>Total cooling capacity: 1.5-10kW</p> <p>Heating capacity: 1.5-10kW</p> <p>Sound pressure level**: 21-59 dB(A)</p>	<ul style="list-style-type: none"> • Different sizes for covering a high-performance range • Timeless design • Proven technology
 <p>HyCassette-Geko®</p>	<p>Design Cassette fan coil unit for installation in Euro-pattern and suspended ceilings</p> <p>Total cooling capacity: 1-4.8kW</p> <p>Heating capacity: 1.5-5.4kW</p> <p>Sound pressure level**: 21-49 dB(A)</p>	<ul style="list-style-type: none"> • Homogenous temperature distribution and regulated air-projection range thanks to our SWIRL technology for providing high comfort • Easy to clean and disinfect for reducing maintenance-time
 <p>HyPower-Geko®</p>	<p>Ducted fan coil unit for suspended ceilings</p> <p>Total cooling capacity: 2.7-12.9kW</p> <p>Heating capacity: 3.1-15kW</p> <p>Sound power level: 46-63 dB(A)</p>	<ul style="list-style-type: none"> • Different sizes for covering a high-performance range • High pressure resistance • Valve equipment mounted at delivery • High quality fan for low sound



*Preliminary data

**Sound pressure with 5m distance; 100m³ room volume; for ducted fan coil units sound power at outlet duct with 50 Pa in middle speed

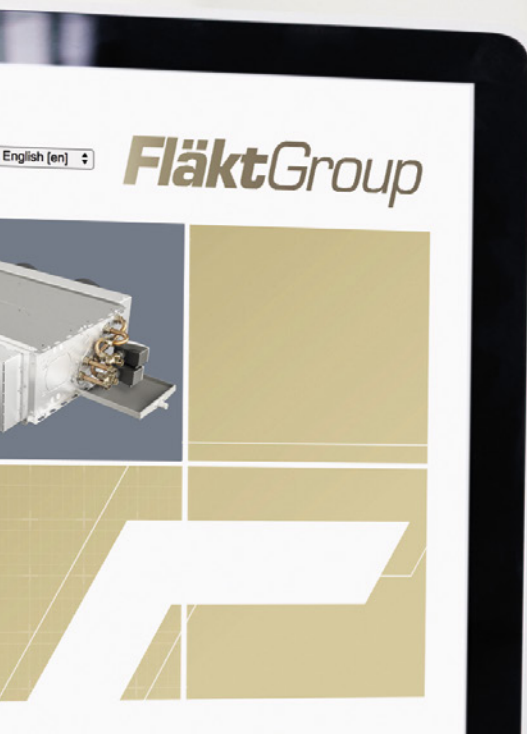
***Performance capacities are based on 2-pipe systems; cooling at 27°C/46% with 7/12 °C water temperature; heating at 20°C with 45/40°C water temperature; for ducted fan coil units with 50 Pa in middle speed



Chilled Beams

Performance Range		Benefits
 Wega II (IQII)	Chilled beam for recessed installation	<ul style="list-style-type: none"> • Factory mounted controls • Comfort and flexibility thanks to Flow Pattern Control combined with adjustable nozzles • Available in X-Flow – high airflow version • Available in hygiene version for smart and easy cleaning
	Length: 120 to 300mm	
	Height: 152, 190, 250mm	
	Air flow range: 11-288m ³ /h	
	Nozzles: 0–36mm	
 Lyra II (IQCC)	Cassette chilled beam for recessed and exposed installation	<ul style="list-style-type: none"> • Ultra silent (<20dB) compact • Comfort and flexibility thanks to Flow Pattern Control, Coanda Safety Control and adjustable nozzles • Integrates control following plug-and-play principle
	Sizes: 600x600 and 600x1200mm (recessed)	
	Sizes: 725x725 and 725x1325mm (exposed)	
	Air flow range: 18-230m ³ /h	
	Nozzles: 0–36mm	
 Nova II (IQFI)	Chilled beam for exposed installation	<ul style="list-style-type: none"> • Attractive design • Comfort and flexibility thanks to Flow Pattern Control, Coanda Safety Control and adjustable nozzles • Factory mounted control • Easy to install with fastening brackets
	Length: 120 to 300mm	
	Height: 152, 190, 250mm	
	Air flow range: 7-277m ³ /h	
	Nozzles: 0–36mm	

All three chilled beams can be equipped with PI actuator to achieve more flexibility and add demand-controlled ventilation to the system. As a result, your chilled beams are becoming pressure independent chilled beams and make the system suitable for many duct-work system types.

Individual solutions for all applications

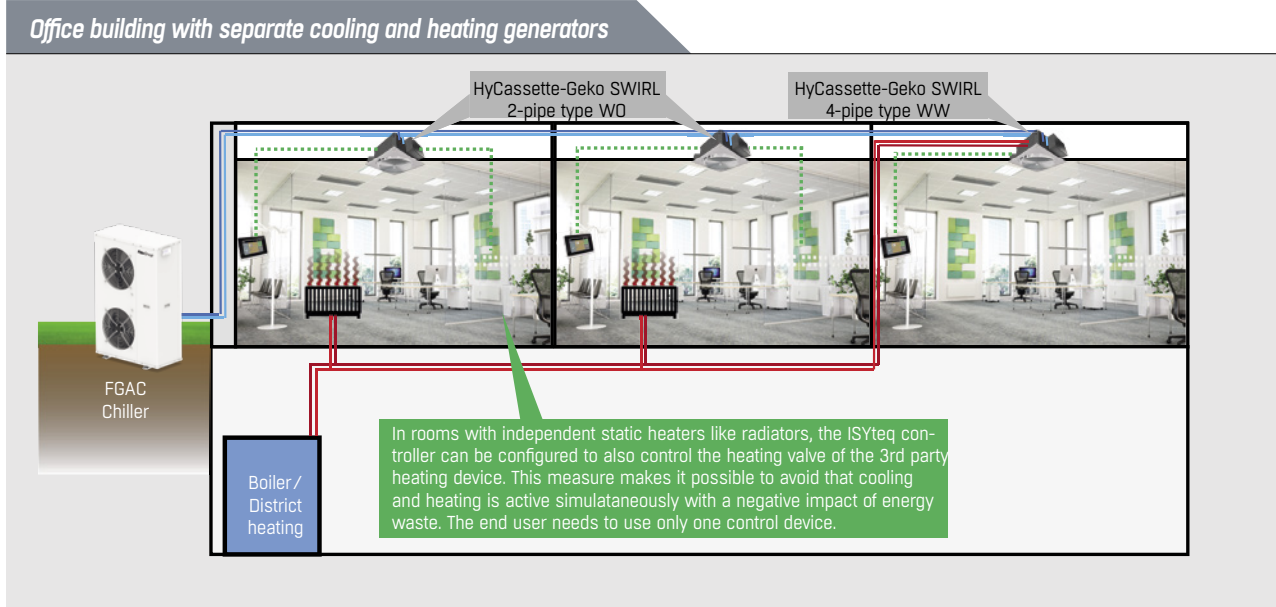

Office buildings with either open-plan offices or smaller room entities, require independent temperature control of each zone. Ideal solutions are Cassette type fan coils (HyCassette-Geko SWIRL, Cassette-Geko Single or Big Single) installed in suspended ceilings combined with ISYteq controls for each zone. The cooling loads are treated by the fan coils. Heating loads can be covered by independent radiators by others or as well by the fan coils in case of 4-pipe units used. Both principles can be combined in a project. Due to the co-existence of cooling and heating sources and the separate water pipe work, cooling and heating is available individually to all zones. The system can be combined with a central air handling unit for the supply of outside air.

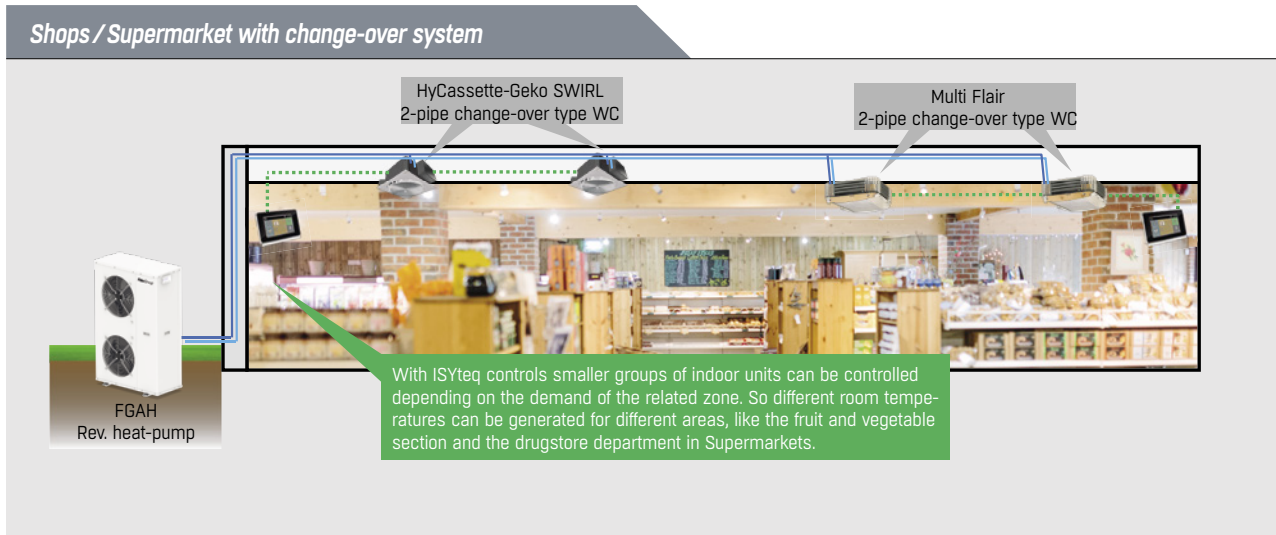

Shops or supermarkets are usually having either heating or cooling demands in the entire showroom. Therefore a 2-pipe change-over system is a very cost-efficient installation system. The benefit is that the installation effort for pipework is reduced by 50 % compared to 4-pipe systems. The system supplies chilled water for cooling during the summer period and warm water for heating in the remaining period. All FläktGroup fan-coil types are available as a change-over version (type WC). Ideal solutions are Cassette type fan coils (HyCassette-Geko SWIRL, Cassette-Geko Single or Big Single) or industrial units of the type MultiFlair. By the use of FGAH reversible heat pumps, the generation of chilled water and warm water can be covered by one unit thus saving further investment costs. The system should be combined with a central air handling unit for the supply of outside air.

Building with chilled beams

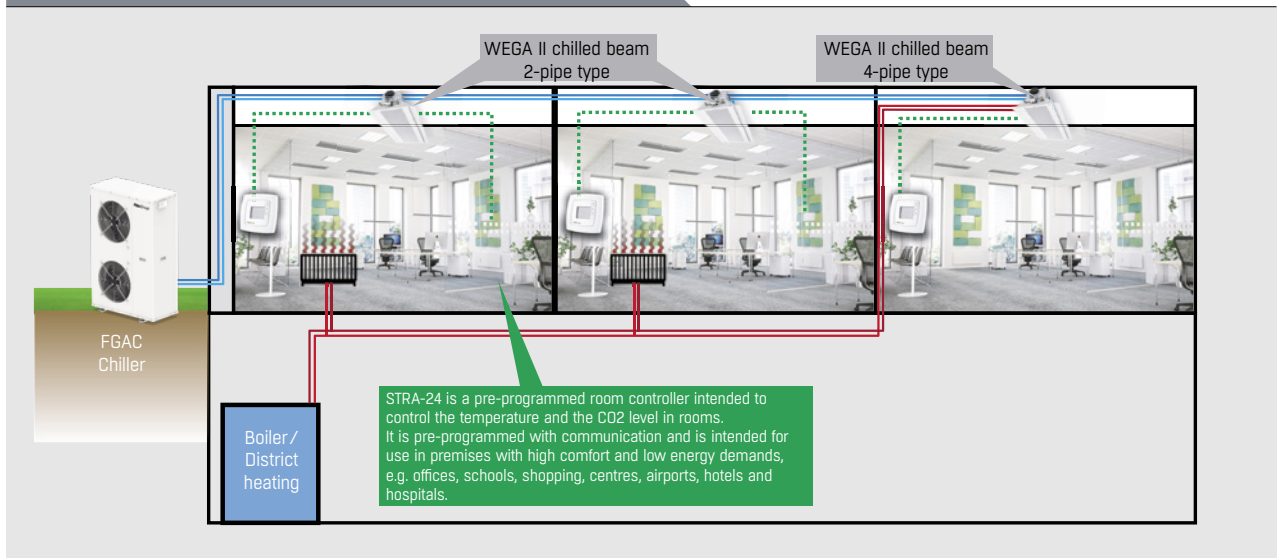

Office buildings, conference rooms and laboratories are premises where outside air supply and individual treatment of cooling and heating loads are required. A system with an air handling unit connected to chilled beams is ideal to combine both tasks. FläktGroup chilled beams are available as 2-pipe units for dry cooling only or 4-pipe units for dry cooling and heating with separate sources for chilled water and warm water. In case of 2-pipe units, heating loads must be covered e.g. by independent radiators by others. Both principles can be combined in a project. Due to the co-existence of cooling and heating sources and the separate water pipe work, cooling and heating is available individually to all zones.

Hotel with HyFlex-Gekos

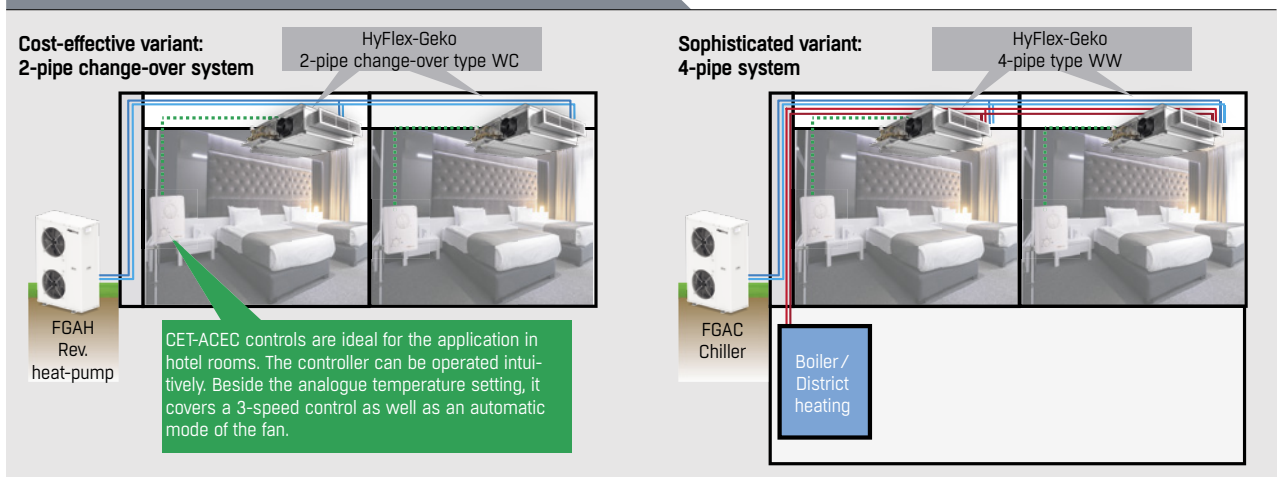

Hotels require ventilation and comfort temperature treatment in the guest rooms. For the comfort treatment 4-pipe fan coils of the HyFlex-Geko series enable individual heating and cooling regardless of the season of the year in all guest rooms. So cooling is also possible in winter without opening windows and thus being affected by street noise. FGAC chillers can be used to generate chilled water during all seasons, meaning from -10 to $+45$ °C ambient temperature. Warm water is generated by third-party sources like boiler or district heating (see right sketch).

A cost-effective system with a lower installation effort is possible by the use of the 2-pipe change-over versions of HyFlex-Geko. This system enables cooling during summer only and heating during winter only. By using FGAH reversible heat pumps, the generation of chilled water in summer and warm water in winter can be covered by one unit (see left sketch).

Future-proof system design with water-based energy transfer

Low installation effort

Hydronic system with FläktGroup mini chiller/heat pump FGAC/H 1005-1014 CD 4/1

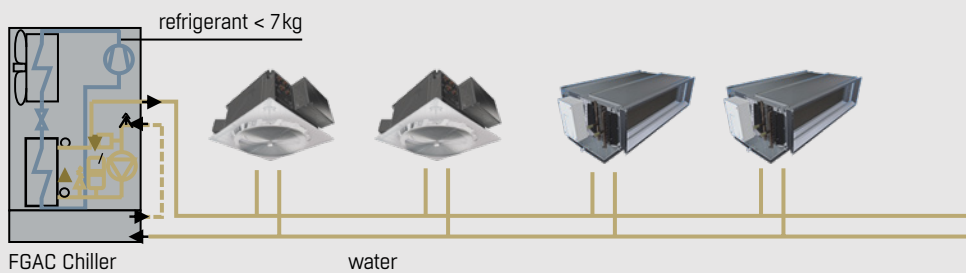

SPLIT-Systems

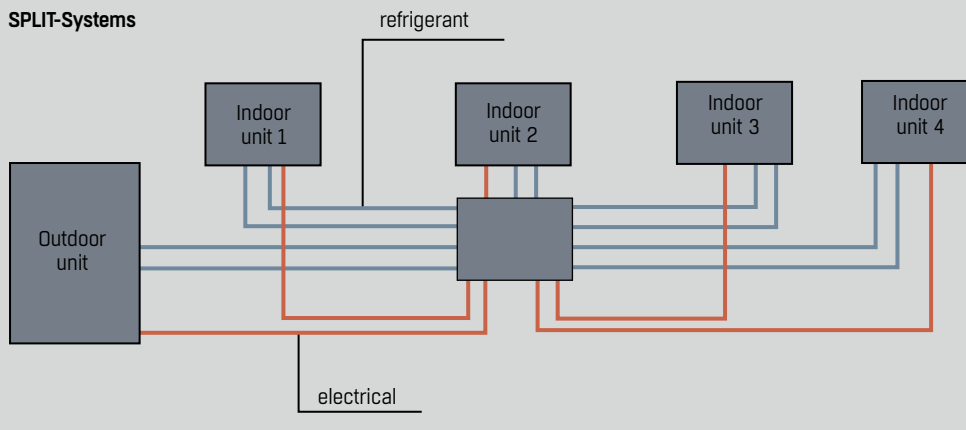

Due to the impacts of the F-Gas directive the need to reduce the refrigerant amount and thus CO₂-equivalent is a sign of the times! Water-based air conditioning system with chillers/reversible heat pumps combined with fan coils/chilled beams result in massively reduced refrigerant charges and CO₂ equivalents compared to split systems!

Example: System with 10 „indoor units“, each 2 kW

SPLIT system R-32 (GWP 675)

Refrigerant charge of multi-split-system 20kW: e.g. 25 kg

CO₂-equivalent: 25,0kgx675 kg (CO₂eq)/kg(refr) = 16,9t CO₂-eq

CHILLER system with R-410A (GWP 2088)

Refrigerant charge of 20kW chiller (FGAC1011CD1): 4,15kg

CO₂-equivalent: 4,15kgx2088 kg (CO₂eq)/kg(refr) = 8,7t CO₂-eq



System configuration made simple

Example

Shop with 20kW cooling load* and 10kW heating load* as change-over system

See page 13 for easy selection of indoor and outdoor unit

Fan coil type: HyCassette-Geko SWIRL (GCC1_WC.SE5)

Cooling/Heating cap. of a fan coil unit in medium fan speed:

Number of fan coils needed to fulfill cooling demand:

Number of fan coils needed to fulfill heating demand:

→ conclusion: 10 units required

2.1kW/1.5kW

$20\text{kW}/2.1\text{kW} = 9,5 \rightarrow 10$ units

$10\text{kW}/1.5\text{kW} = 6.7 \rightarrow 7$ units

Outdoor unit (reversible heat pump)

FGAH 1012 CD1

→ can supply up to 12 fan-coils

→ cooling 24.1kW, heating 16.7kW

→ medium mass flow 4827kg/h

4827 kg/h/10 fan-coils = 483kg/h

Medium mass flow per fan coil unit:

→ re-calculate fan coils with resulting mass flow

* related to -16 °C winter condition and +35 °C summer condition



Easy selection

2-pipe system

with FGAC CD 4/1 chiller and chilled beams

The following allocation table exemplarily shows selected types of FläktGroup chilled beams in 2-pipe cooling only in dry conditions combined with chillers of the FGAC CD 4/1 series for the chilled water supply. The table refers to chilled beams of the same type combined with one chiller. For individual combinations of different types of chilled beams in one project as well as other types and sizes or a cascade of multiple chillers, please ask your FläktGroup sales office. It is recommended to individually recalculate the chilled beams with the actual mass flow.

2-pipe system

primary circuit:
summer +35°C,
medium 13/18°C,
water



Cooling capacity [kW]	[°C]	FGAC ___ CD4 230 V/1~ +N/50Hz					FGAC ___ CD4 400 V/1~ +N/50Hz					
		1005	1006	1007	1008	1009	1010	1011	1012	1013	1014	
		13/18	13/18	13/18	13/18	13/18	13/18	13/18	13/18	13/18	13/18	13/18
		5.1	7.2	9.4	12.6	15.2	17.4	23.0	28.6	34.6	40.6	

WEGA II IQII-240-11-13-2-1

Air vol. flow¹ [m³/h] 122
Sound press.³ [dB(A)] 20
Cooling cap. total⁴ [kW] 0.8



6 8 11 15 18 20 27 34 41 48

WEGA II IQII-180-11-07-2-1

Air vol. flow¹ [m³/h] 94
Sound press.³ [dB(A)] 20
Cooling cap. total⁴ [kW] 0.7



7 9 13 17 21 24 31 39 47 56

NOVA II IQFI-270-21-07-2

Air vol. flow¹ [m³/h] 122
Sound press.³ [dB(A)] 21
Cooling cap. total⁴ [kW] 1.0



5 7 9 12 15 17 22 28 34 40

NOVA II IQFI-180-21-07-2

Air vol. flow¹ [m³/h] 90
Sound press.³ [dB(A)] 21
Cooling cap. total⁴ [kW] 0.6



7 11 14 19 23 26 35 44 53 62

LYRA II IQCC-120-12-1-04-0

Air vol. flow¹ [m³/h] 184
Sound press.³ [dB(A)] 21
Cooling cap. total⁴ [kW] 0.6



8 11 15 20 24 28 37 46 56 66

LYRA II IQCC-060-12-1-04-0

Air vol. flow¹ [m³/h] 115
Sound press.³ [dB(A)] 25
Cooling cap. total⁴ [kW] 0.4



12 18 23 31 38 43 57 71 86 101

X = Number of connectable units

¹ primary air flow introduced by air handling unit, primary air temperature 18°C, Total air pressure drop 70 Pa;

² A hydraulic separator FGHM100/FGHM200 is used to decouple primary and secondary circuits. A 3-way-valve must be applied to generate 15 °C for the chilled beams or higher in case of undershooting the dew point;

³ The sound pressure levels are calculated from the sound power values at 5 m distance and 100 m² room size;

⁴ room 24°C, 50 %; ceiling temp 24.5 °C; water 15/18 °C without glycol; additional cooling power is provided by introducing the fresh air with 6 K below room temperature

4-pipe system

with FGAC CD4/1 chiller and fan coils

The following allocation table exemplarily shows selected types of FläktGroup fan coil units in a 4-pipe version combined with chillers of the FGAC CD 4/1 series for the chilled water supply. A heating source by others, like a boiler or district heating must be available for the warm water supply. The table refers to fan coil units of the same type combined with one chiller. For individual combinations of different fan-coils types in one project as well as other fan-coil types and sizes or a cascade of multiple chillers, please ask your FläktGroup sales office. It is recommended to individually recalculate the fan coils with the actual mass flow.

4-pipe system

summer +35°C,
medium 7/12°C,
30% ethylene glycol



Cooling capacity [kW]	[°C]	FGAC ___ CD4 230V/1~ +N/50Hz					FGAC ___ CD4 400V/1~ +N/50Hz				
		1005	1006	1007	1008	1009	1010	1011	1012	1013	1014
		7/12	7/12	7/12	7/12	7/12	7/12	7/12	7/12	7/12	7/12
		4.2	5.9	7.9	10.4	13.0	15.1	20.1	24.3	29.0	34.2

Medium mass flow

832 kg/h	1194 kg/h	1584 kg/h	2090 kg/h	2597 kg/h	3028 kg/h	4026 kg/h	4884 kg/h	5821 kg/h	6857 kg/h
----------	-----------	-----------	-----------	-----------	-----------	-----------	-----------	-----------	-----------

HyCassette-Geko with SWIRL outlet, GCC1.WWSE5
 Air vol. flow [m³/h] 210 **390** 670
 Sound press.³ [dB(A)] 21 **37** 52
 Cooling cap. total⁴ [kW] 1.5 **2.1** 2.7
 Heating cap.⁵ [kW] 1.3 **1.8** 2.5

408 kg/h



2	3*	3	5	6	7	9	11	14	16
---	----	---	---	---	---	---	----	----	----

Cassette-Geko Single, GCB1.UWWSE5
 Air vol. flow [m³/h] 250 **480** 850
 Sound press.³ [dB(A)] 21 **37** 51
 Cooling cap. total⁴ [kW] 1.4 **2.0** 2.4
 Heating cap.⁵ [kW] 2.3 **3.5** 4.9

376 kg/h



2	3	4	5	6	8	10	12	15	18
---	---	---	---	---	---	----	----	----	----

Cassette-Geko Big Single, GCB1.UWWSE5
 Air vol. flow [m³/h] 620 **920** 1530
 Sound press.³ [dB(A)] 26 **36** 50
 Cooling cap. total⁴ [kW] 3.3 **3.9** 4.8
 Heating cap.⁵ [kW] 5.6 **7.3** 9.9

767 kg/h



1		2		3	4*	5	6	7	8
---	--	---	--	---	----	---	---	---	---

HyFlex-Geko Size 2, GS2MM.UWWH1%
 Air vol. flow [m³/h] 165 **255** 575
 Sound press.³ [dB(A)] 22 **32** 53
 Cooling cap. total⁴ [kW] 1.2 **1.5** 1.8
 Heating cap.⁵ [kW] 1.4 **1.8** 2.6

273 kg/h



3	4	5	7	9	11	14	17	21	25
---	---	---	---	---	----	----	----	----	----

HyFlex-Geko Size 3, GSMH.UWWH3.8EF%
 Air vol. flow [m³/h] 240 **430** 790
 Sound press.³ [dB(A)] 21 **34** 49
 Cooling cap. total⁴ [kW] 1.7 **2.3** 2.9
 Heating cap.⁵ [kW] 2.0 **2.8** 3.7

428 kg/h



1	2	3	4	6	7	9	11	13	16
---	---	---	---	---	---	---	----	----	----

HyPower-Geko Size 2, GH22.HWW3.SE0C2
 Air vol. flow [m³/h] 425 **1200** 1540
 Sound press.³ [dB(A)] N/A N/A N/A
 Cooling cap. total⁴ [kW] 3.4 **6.9** 7.9
 Heating cap.⁵ [kW] 5.1 **10.9** 12.8

1325 kg/h



		1			2		3	4	5
--	--	---	--	--	---	--	---	---	---

HyPower-Geko Size 4, GH42.HWW3.SE0C2
 Air vol. flow [m³/h] 755 **2190** 2880
 Sound press.³ [dB(A)] N/A N/A N/A
 Cooling cap. total⁴ [kW] 6.1 **13.3** 15.4
 Heating cap.⁵ [kW] 9.1 **20.0** 23.9

2585 kg/h



					1			2	
--	--	--	--	--	---	--	--	---	--

X = Number of connectable units

¹ The indoor units are dimensioned at the medium fan step; the max. fan step is intended for short-term and fast pre-conditioning of rooms; the capacities shown at the max speed can not be covered at all indoor units simultaneously, so these values must be considered as non-binding; ² The sound pressure levels are calculated from the sound power values at 5 m distance and 100 m³ room size; ³ Sound pressure at 5 m distance; ⁴ room 27°C, 46%, medium 7/12°C, 30% ethylene glycol in med fan step, min/max fan step with identical medium mass flow; ⁵ room 20°C, medium 65/55°C, without glycol in med fan step; * Capacity of fan-coil decreased slightly; alternatively individual dimensioning

2-pipe change-over system

with FGAH CD4/1 reversible heat-pump

The following allocation table exemplarily shows selected types of FläktGroup fan coil units in 2-pipe change-over execution combined with reversible heat pumps of the FGAH CD 4/1 series for the chilled water and warm water supply.

The table refers to fan coil units of the same type combined with one reversible heat pump. For individual combinations of different fan-coils types in one project as well as other fan-coil types and sizes or a cascade of multiple heat-pumps, please ask your FläktGroup sales office. It is recommended to individually recalculate the fan coils with the actual mass flow.

2-pipe change-over system

summer +35°C, medium 7/12°C,
30% ethylene glycol
winter -16°C, medium 35°C/
mass flow as in cooling,
30% ethylene glycol



		FGAH ___ CD4 230 V/1~ +N/50Hz					FGAH ___ CD1 400 V/3~ +N/50Hz				
		1005	1006	1007	1008	1009	1010	1011	1012	1013	1014
Cooling capacity	[°C]	7/12	7/12	7/12	7/12	7/12	7/12	7/12	7/12	7/12	7/12
	[kW]	4.1	5.7	7.3	10.2	12.5	14.3	18.2	24.1	28.6	34.2
Heating capacity	[°C]	35.0/ 31.4	35.0/ 31.2	35.0/ 30.7	35.0/ 31.6	35.0/ 32.0	35.0/ 31.8	35.0/ 31.8	35.0/ 31.6	35.0/ 32.3	35.0/ 31.8
	[kW]	2.9	4.3	6.4	6.5	7.5	9.4	12.0	16.7	15.8	22.4

Medium mass flow

820 kg/h	1153 kg/h	1467 kg/h	2053 kg/h	2502 kg/h	2873 kg/h	3655 kg/h	4827 kg/h	5746 kg/h	6857 kg/h
----------	-----------	-----------	-----------	-----------	-----------	-----------	-----------	-----------	-----------

HyCassette-Geko SWIRL, GCC1.U.WC.SE5

Air vol. flow	[m³/h]	210	390	670
Sound press. ³	[dB(A)]	21	37	52
Cooling cap. total ⁴	[kW]	1.4	2.1	2.7
Heating cap. ⁵	[kW]	0.9	1.5	2.1

402 kg/h



2	3	5	6	7	9	12	14	17
---	---	---	---	---	---	----	----	----

Cassette-Geko Single, GCS1.UWC.SE5

Air vol. flow	[m³/h]	250	480	850
Sound press. ³	[dB(A)]	21	37	51
Cooling cap. total ⁴	[kW]	1.7	2.4	3.1
Heating cap. ⁵	[kW]	1	1.6	2.3

467 kg/h



2*	2	3	4	5	6	7	10	12	14
----	---	---	---	---	---	---	----	----	----

Cassette-Geko Big Single, GCB1.UWC.SE5

Air vol. flow	[m³/h]	620	920	1530
Sound press. ³	[dB(A)]	26	36	50
Cooling cap. total ⁴	[kW]	4.5	5.9	7.9
Heating cap. ⁵	[kW]	2.7	3.7	5.2

1134 kg/h



1	2	3	4	5	6
---	---	---	---	---	---

HyFlex-Geko Size 2, GS2MM.UWWH1%

Air vol. flow	[m³/h]	165	255	575
Sound press. ³	[dB(A)]	22	32	53
Cooling cap. total ⁴	[kW]	1.3	1.7	2.4
Heating cap. ⁵	[kW]	2.6	3.8	6.4

311 kg/h



3	5*	4	6	8	9	11	15	18	22
---	----	---	---	---	---	----	----	----	----

HyFlex-Geko Size 3, GSMH.UWWH3.8EF%

Air vol. flow	[m³/h]	240	430	790
Sound press. ³	[dB(A)]	21	34	49
Cooling cap. total ⁴	[kW]	2.1	2.8	5.4
Heating cap. ⁵	[kW]	3.2	5.4	9.0

515 kg/h



1	2	3	4	5	7	9	11	13
---	---	---	---	---	---	---	----	----

HyPower-Geko Size 2, GH22.HWC3.SE0C2

Air vol. flow	[m³/h]	440	1200	1595
Sound press. ³	[dB(A)]	N/A	N/A	N/A
Cooling cap. total ⁴	[kW]	3.5	6.9	8.0
Heating cap. ⁵	[kW]	2.1	4.8	5.9

1325 kg/h



1	2	3	4	5
---	---	---	---	---

HyPower-Geko Size 4, GH43.HWC3.SE0C2

Air vol. flow	[m³/h]	755	2190	2880
Sound press. ³	[dB(A)]	N/A	N/A	N/A
Cooling cap. total ⁴	[kW]	6.9	15.7	18.8
Heating cap. ⁵	[kW]	3.8	10.27	12.91

2955 kg/h



1	2
---	---

X = Number of connectable units

¹ The indoor units are dimensioned at the medium fan step; the max. fan step is intended for short-term and fast pre-conditioning of rooms; the capacities shown at the max speed can not be covered at all indoor units simultaneously, so these values must be considered as non-binding; ² The sound pressure levels are calculated from the sound power values at 5 m distance and 100 m³ room size; ³ Sound pressure at 5 m distance; * room 27°C, 46%; medium 7/12°C, 30% et. glycol in med fan step; ⁴ room 20°C, medium supply 35°C, mass flow as in cooling, 30% et. glycol; * Capacity of fan-coil decreased slightly, alternatively individual dimensioning

Performance data

Unit type FGA C/H 1005-1014 CD 4/1

Chiller

Unit type FGAC ___ CD4/1		1005	1006	1007	1008 ⁹	1009 ⁹	1010	101	1012	1013	1014
Refrigeration capacity ¹	[kW]	4,3	6,1	8,1	10,6	12,9	15,5	20,6	25,0	29,8	35,1
Unit power consumption	[kW]	1,6	2,1	2,8	3,6	4,7	5,4	7,2	8,7	10,0	11,8
230V / 1 Phase		●	●	●	●	●					
400V / 3 Phase + N					●	●	●	●	●	●	●
SEER ⁴		4,38	4,43	4,93	4,39	4,78	4,31	4,31	4,52	4,52	4,57
η_s (cooling) ⁴	[%]	172	174	194	172	188	169	169	178	178	180

Refrigeration circuit

compressors		1	1	1	1	1	1	1	1	1	1
Min. part load share	[%]	25	25	25	25	25	25	25	25	25	25

Noise levels

Sound pressure level ⁷	[dB(A)]	33	34	35	38	39	43	43	43	44	45
Sound power level	[dB(A)]	64	65	66	69	70	74	74	75	76	77

Dimensions and weight

A (length)	[mm]	900	900	900	900	900	900	1450	1450	1450	1700
B (width)	[mm]	370	370	420	420	420	420	550	550	550	650
H (height)	[mm]	940	940	1240	1240	1240	1390	1200	1700	1700	1700
Weight ⁸	[kg]	75	80	95	110	125	135	190	250	270	305

Rev. Heat-Pump

Unit type FGAH ___ CD4/1		1005	1006	1007	1008 ⁹	1009 ⁹	1010	101	1012	1013	1014
Refrigeration capacity ¹	[kW]	4,2	5,9	7,5	9,9	12,4	14,7	18,7	24,7	29,4	35,1
Heating capacity ²	[kW]	4,6	6,4	8,5	11,0	14,3	17,2	21,7	26,1	32,3	38,1
Unit power consumption ³		1,6	2,1	2,7	3,6	4,5	5,2	7,0	9,0	10,5	12,7
230V / 1 Phase		●	●	●	●	●					
400V / 3 Phase + N					●	●	●	●	●	●	●
SCOP ⁵		3,59	3,89	4,15	3,54	3,81	3,67	3,56	3,77	3,80	3,70
η_s (heating) ⁵	[%]	140	153	163	139	149	144	139	148	149	145
Efficiency class ^{5, 6}		A+	A++	A++	A+	A+	A+	A+	A+	A+	A+

Refrigeration circuit

compressors		1	1	1	1	1	1	1	1	1	1
Min. part load share	[%]	25	25	25	25	25	25	25	25	25	25

Noise levels

Sound pressure level ⁷	[dB(A)]	33	34	35	38	39	43	43	43	44	45
Sound power level	[dB(A)]	64	65	66	69	70	74	74	75	76	77

Dimensions and weight

A (length)	[mm]	900	900	900	900	900	900	1450	1450	1450	1700
B (width)	[mm]	370	370	420	420	420	420	550	550	550	650
H (height)	[mm]	940	940	1240	1240	1240	1390	1200	1700	1700	1700
Weight ⁸	[kg]	75	80	95	110	125	135	190	250	270	305

¹ Applied conditions: chilled water temperature (inlet/outlet) 12/7 °C; Outdoor temperature 35 °C; ² Applied conditions: warm water temperature (inlet/outlet) 40/45 °C; Outdoor temperature 7 °C - 87 % r.h.;

³ Total consumption in cooling mode; values for heating mode are minimally different; ⁴ According EU 2016/2281, referring to units with built-in pump;

⁵ According (EU) No. 813/ 2013, referring to low temperature application, average climate and with built-in pump; ⁶ Seasonal space heating energy efficiency class; ⁷ At 10m distance; informative value calculated from the sound power level;

⁸ Valid for the basic unit without substructure buffer and without built-in pump; ⁹ Values refer to 230 V units; values for 400 V units are minimally different

EXCELLENCE IN SOLUTIONS

WWW.FLAKTGROUP.COM

VERSATILE COMPLETE SYSTEMS

FläktGroup is the European market leader for smart and energy efficient Indoor Air and Critical Air solutions to support every application area. We offer our customers innovative technologies, high quality and outstanding performance supported by more than a century of accumulated industry experience. The widest product range in the market, and strong market presence in 65 countries worldwide, guarantee that we are always by your side, ready to deliver Excellence in Solutions.

PRODUCT FUNCTIONS BY FLÄKTGROUP

Air Treatment | Air Movement | Air Diffusion | Air Distribution
Air Filtration | Air Management | Air Conditioning & Heating
Controls | Service

» Learn more on www.flaktgroup.com
or contact one of our offices